

**ONE TECH VIETNAM MANUFACTURING AND
TRADING COMPANY LIMITED**



“Credibility creates brand identity”

CATALOGUE

STORAGE RACK



- ◆ **Slotted angle rack**
- ◆ **Heavy Duty Rack**
- ◆ **Medium Duty Rack**
- ◆ **Warehouse Design**



**OPEN
LETTER!**

*Dear Valued
Customers*

Dear Valued Customers,

First of all, One Tech Vietnam Manufacturing and Trading Company Limited would like to send to our customers and partners wishes for health, happiness and success.

Currently, One Tech is a leading unit in the field of manufacturing, construction and installation of racks - supermarket equipment in the market. Owing a team of experienced technicians and a high-tech production line system and a closed operating process, One Tech is proud to be a firm belief in our customers and partners in the journey of creating efficient storage and display spaces.

Building the core motto of accompanying and developing together, One Tech always listens and understands the requirements and wishes of customers, thereby constantly innovating modern production systems and professional working styles. One Tech always accompanies our partners and protects the interests of consumers.

One Tech provides a wide range of products: Supermarket racks, V-hole steel racks, Medium duty storage racks, heavy-duty industrial racks, sales management software, payment equipment, and so on to provide optimal, effective and durable solutions.

Over the years, the trust and satisfaction of more than 200,000 domestic and foreign partners and customers is what One Tech has achieved and made a strong mark on. This is also the motivation for One Tech Vietnam to continue to improve and develop to bring more quality products.

On behalf of One Tech Vietnam Manufacturing and Trading Company Limited, I would like to express my most sincere thanks to our customers and partners for trusting and cooperating with us. Certainly, with the belief and built success, One Tech will always accompany and contribute to the development steps of our customers and partners in the future.



VISION AND STRATEGY

VISSION

ONE TECH VIETNAM orients to become a pioneering, constant and sustainable developing company by making the right decisions in investment and exploiting the creative potential in the field of engineering and technology. We always strive to meet all requirements of customers, giving members the conditions to maximize their business talents and a happy and successful life. It is material fulfillment and spiritual abundance, shared responsibility to the community and society.

STRATEGY

Building the company to become one of the leading companies in Vietnam, reaching out to the world.

As a leading unit in the field of manufacturing and trading supermarket racks, grocery display racks, sale software, storage racks, heavy-duty medium-duty racks, receipt printers, labels & barcodes printers, security magnetic gates and supermarket installation accessories.

Strengthen cooperation with domestic and foreign partners to maximize their strengths in business activities



“ **Unity & team spirit**
is our motto of operation”



BUILDING FACTORY 01

Equipped with a series of specialized trucks and cranes for loading and unloading goods, serving the installation of supermarket racks throughout the North



MEETING ISO STANDARD

Obtain quality certificate ISO 9001:2015

REACHING OUT TO THE WORLD
Export products to the world.



2012



ESTABLISHMENT OF COMPANY

The first business of the company is importing components from the foreign country

2014

2015



ESTABLISHMENT OF BRANCHES IN 3 REGIONS NORTH - CENTRAL - SOUTH

Quickly understand the market throughout Vietnam

2018

2022



BUILDING FACTORY 02

Obtain quality certificate ISO 9001:2015
Build the 2nd Electro-Static power coating furnace which is the most modern in Vietnam

2023

■ TABLE OF CONTENT

Company introduction	Page 1
Vision and Strategy	Page 2
Business Roadmap.....	Page 3
Storage Rack.....	Page 5
1. Slotted angle rack	Page 7
2. DIY adjustable slotted angle rack	Page 10
3. Light duty slotted angle rack	Page 13
4. Medium duty rack.....	Page 17
5. Selective rack	Page 21
6. Double Deep rack.....	Page 25
7. Mezzanine rack.....	Page 29
8. Drive In rack	Page 33
9. Pallet flow rack.....	Page 37
10. Cantilever rack.....	Page 41
Strategic Partners.....	Page 45

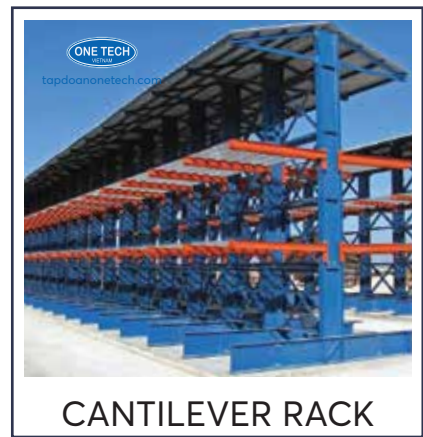

STORAGE RACK



Column



V3.8*3.8



V3*3



V3*5



V3*6



V4*6



50*30



50*60



60*60

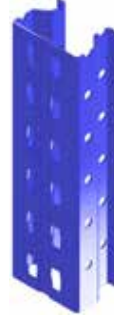

90*60



90*70



90*120



100*60

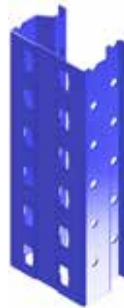

110*70



120*70

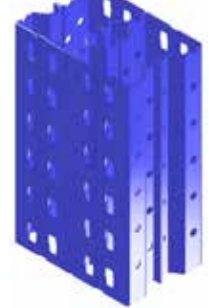

180*120

Beam



Beam V-Rack



Beam 30*80



Beam 30*90



Beam 30*60



Beam 40*80



Beam 50*80



Beam 50*100



Beam 50*120



Beam 50*140



Beam 50*160







Beam 50*200

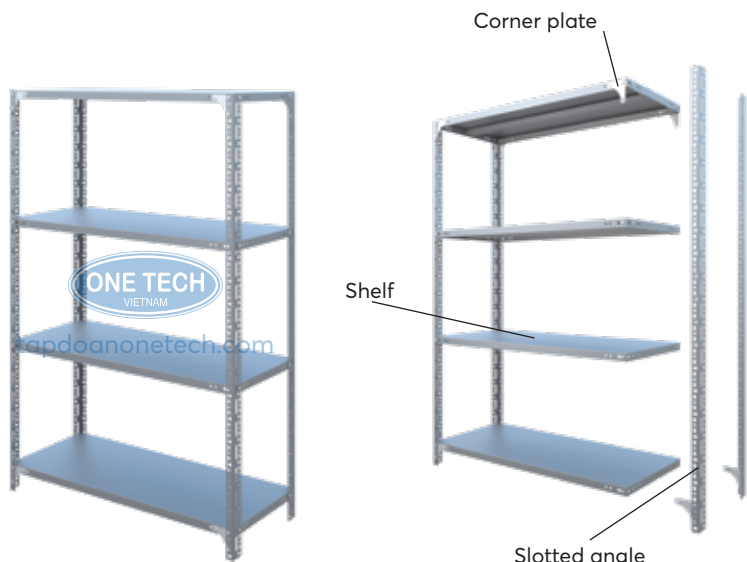

1. SLOTTED ANGLE RACK

Common V-hole iron racks are also known by many different names such as multi-purpose shelves, multi-purpose iron shelves, etc. These can be considered as light duty storage racks assembled from V-hole iron bars along with trays for cargo loading with a maximum cargo loading capacity of 120kg/floor.

It is easy to see shelves unit made from V-hole iron in warehouses, offices or in family. Shelves can be modified to be used for many different purposes depending on your wishes.

	Slotted angle			
	Corner plate			
	Shelf			
 ONE TECH VIETNAM MANUFACTURING AND TRADING COMPANY LIMITED	PRODUCT		FULL NAME	
	<h2>SLOTTED ANGLE RACK</h2>		DESIGN	
			TECHNICIAN	LE VAN NGHI
			CHECKED BY	NGUYEN CAO CUONG
			APPROVED BY	NGUYEN VAN TRUNG

Technical specifications

Slotted angle rack	Unit	Standard dimensions
Height	mm	1000; 1200; 1500; 2000; 2200; 2400; 3000
Width	mm	300; 400; 500; 600
Length	mm	600; 800; 1000; 1200; 1500
Loading capacity	kg	100 - 200kg/ tầng
Slotted angle iron type		V3x3; V3x5; V4x4; V4x6.
Slotted angle iron thickness	mm	1.2 – 2.0mm
Thickness of shelf	mm	0.6; 0.8mm
Material		Stainless iron, Electrostatic powder coating iron
Color		Milky white, grey or painted as required

1. SLOTTED ANGLE RACK

Slotted angle column parameters

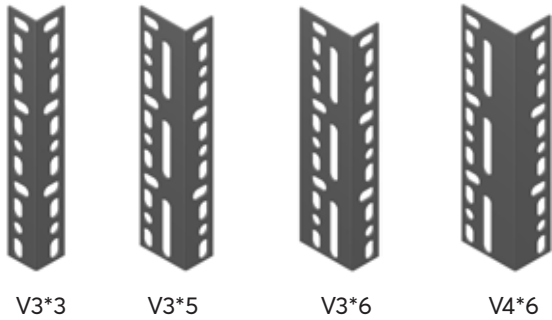

Slotted angle column

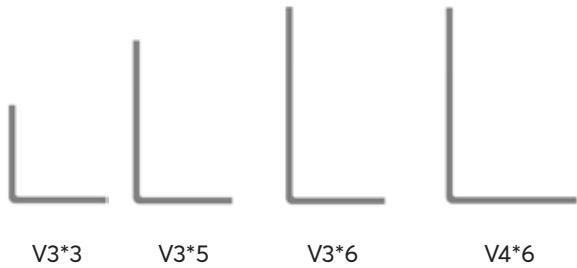

Slotted angle column section

Shelf parameters

Thickness of shelf

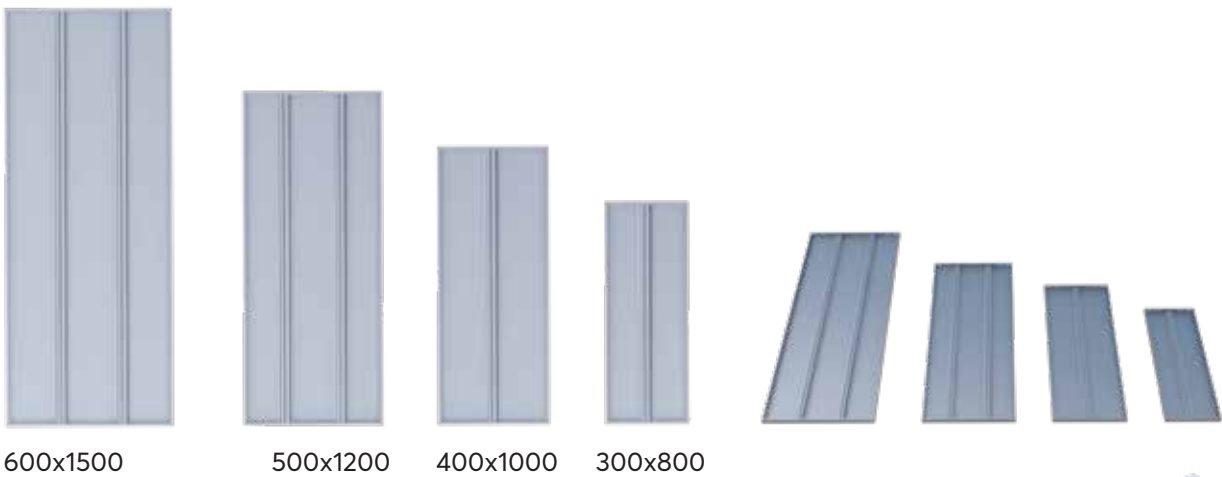

Popular rack models

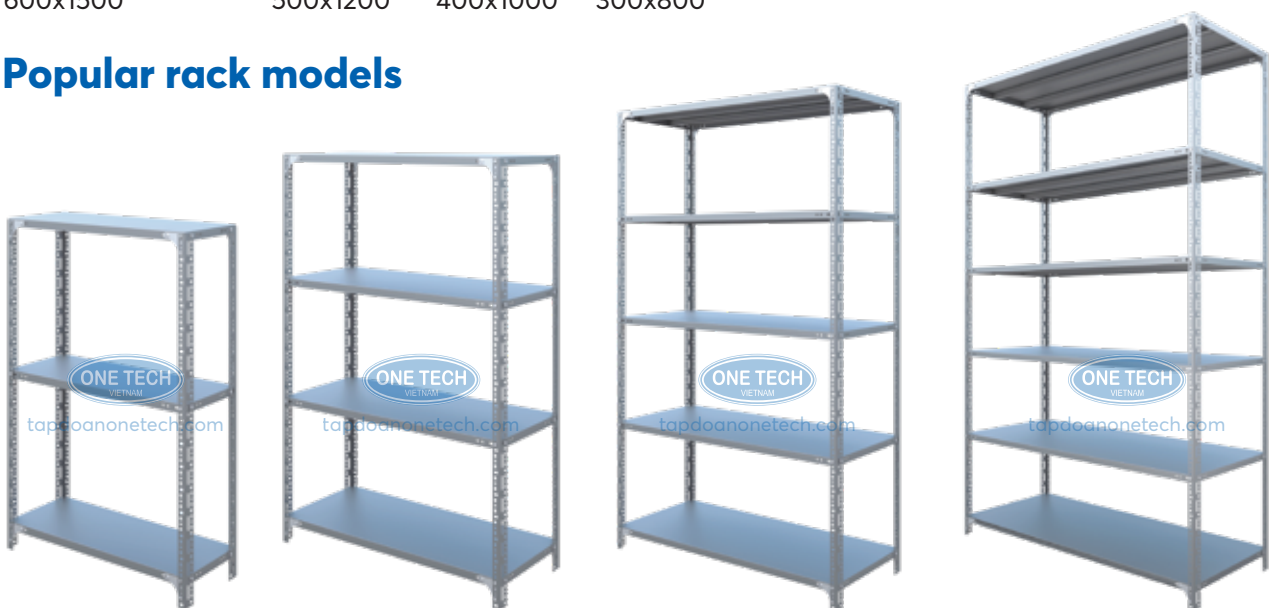

H120 x 3 tiers

H150 x 4 tiers

H200 x 5 tiers

H240 x 6 tiers



1. SLOTTED ANGLE RACK

Principles of Storing and Taking out

This is a line of shelves used to display goods in families and shops, so storing and taking out is done manually.

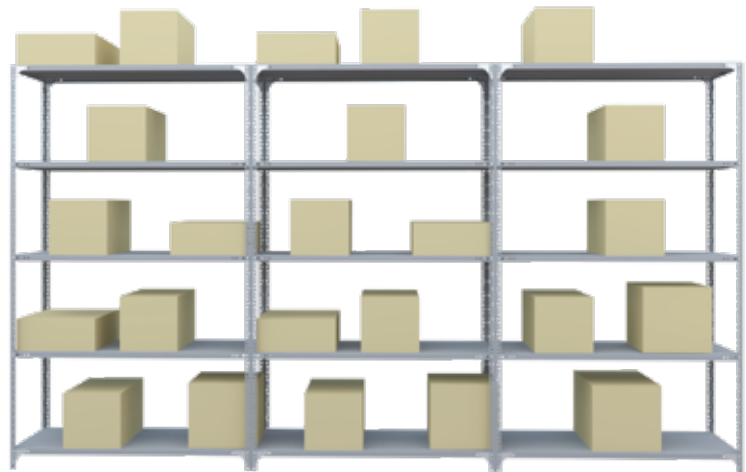

Strong points

- Versatile V-hole iron rack for flexible use space saving
- V-hole iron rack with reasonable price
- Rack has an assembling structure, convenient for disassembly and movement

Weak points

- Small loading capacity, suitable for small and medium-sized goods
- High risk of buying poor quality products on the market



2. DIY ADJUSTABLE SLOTTED ANGLE RACK

The Assembling V iron rack is a type of shelf designed to be assembled without bolts and nuts. Used to store goods and utensils with light loads to save space effectively at extremely reasonable costs.

	Slotted angle			
	Corner plate			
	Shelf			
	Connector			
<p>ONE TECH VIETNAM MANUFACTURING AND TRADING COMPANY LIMITED</p>	PRODUCT		FULL NAME	
	<p>DIY ADJUSTABLE SLOTTED ANGLE RACK</p>		DESIGN	
			TECHNICIAN	LE VAN NGHI
			CHECKED BY	NGUYEN CAO CUONG
			APPROVED BY	NGUYEN VAN TRUNG

Technical specifications

Slotted angle rack	Unit	Standard dimensions
Height	mm	1000; 1200; 1500; 2000; 2200; 2400; 3000
Width	mm	300; 400; 500; 600
Length	mm	600; 800; 1000; 1200; 1500
Loading capacity	kg	100 - 200kg/ tầng
Slotted angle iron type		V3x3; V3x5; V4x4; V4x6.
Slotted angle iron thickness	mm	1.2 - 2.0mm
Thickness of shelf	mm	0.6; 0.8mm
Material		Stainless iron, Electrostatic powder coating iron
Color		Milky white, grey or painted as required

2. DIY ADJUSTABLE SLOTTED ANGLE RACK

Slotted angle column parameters

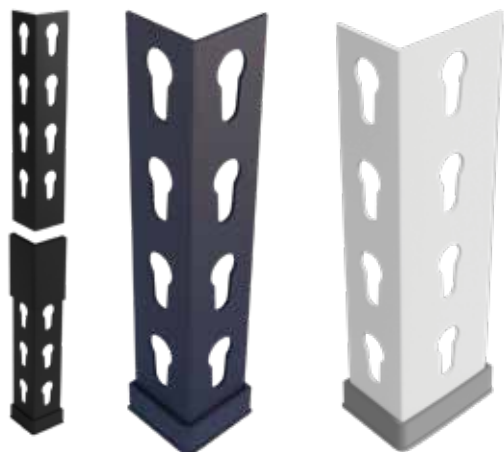

Column foot



V3.8*3.8

V3*5

Slotted angle section

Color and models of Assembling V rack



Grey

Color code 481

Color code 4602

Color code 317

Wood grain color code



Wood color code 481



Wood color code 4602



Wood color code 317

2. DIY ADJUSTABLE SLOTTED ANGLE RACK

Detail of connector



Principles of Storing and Taking out

This is a line of shelves used to display goods in families and shops, so storing and taking out is done manually.



Strong point

- Versatile V-hole iron rack for flexible use
- Space saving
- V-hole iron rack with reasonable price
- Rack has a assembling structure, convenient for disassembly and movement

Weak point

- Small loading capacity, suitable for small and medium-sized goods
- High risk of buying poor quality products on the market



3. LIGHT DUTY SLOTTED ANGLE RACK

Light duty V iron rack is a type of shelf designed to be assembled without bolts and nuts. Used to store goods and utensils with light loads to save space effectively at extremely reasonable costs.

	Slotted angle			
	Beam			
	Shelf			
 <p>ONE TECH VIETNAM MANUFACTURING AND TRADING COMPANY LIMITED</p>	PRODUCT NAME		FULL NAME	
	<h2>LIGHT DUTY SLOTTED ANGLE RACK</h2>		DESIGN	
			TECHNICIAN	LE VAN NGHI
			CHECKED BY	NGUYEN CAO CUONG
			APPROVED BY	NGUYEN VAN TRUNG

Technical specifications

Slotted angle rack	Unit	Standard dimensions
Height	mm	1000; 1200; 1500; 2000; 2200; 2400; 3000
Width	mm	300; 400; 500; 600
Length	mm	600; 800; 1000; 1200; 1500
Loading capacity	kg	100 - 200kg/ tầng
Slotted angle iron type		V3x3; V3x5; V4x4; V4x6.
Slotted angle iron thickness	mm	1.2 – 2.0mm
Thickness of shelf	mm	0.6; 0.8mm
Material		Stainless iron, Electrostatic powder coating iron
Color		Milky white, grey or painted as required

3. LIGHT DUTY SLOTTED ANGLE RACK

Slotted angle column parameters

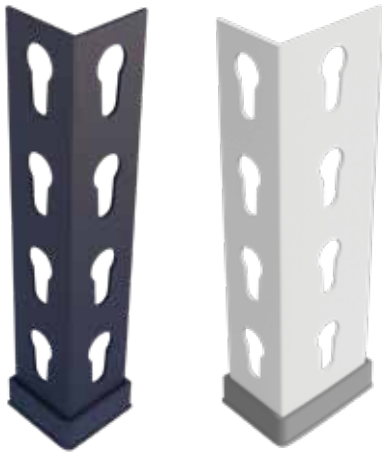

Column foot

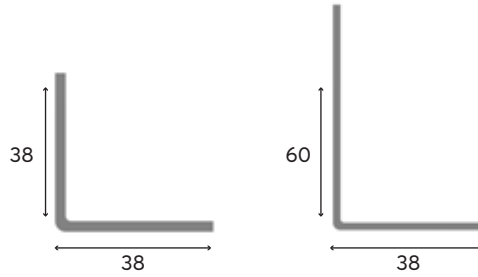

Slotted angle column section

Beam

Beam is a different detail from the common V rack and the assembling V rack models. Beams will help the loading capacity of the shelf better

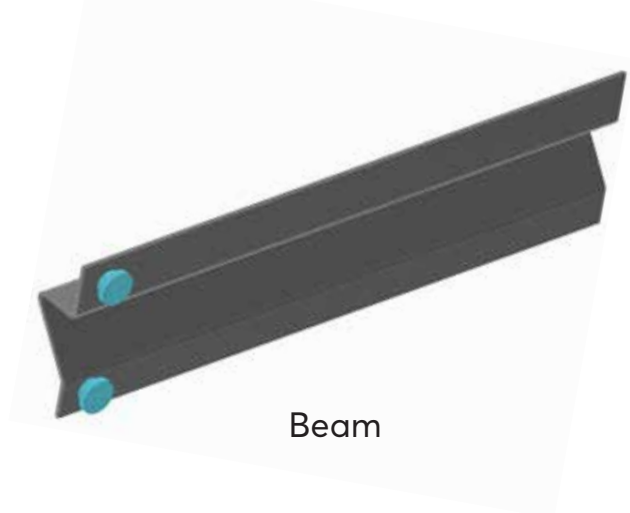

Beam

Colors and Models of Light duty slotted angle rack



Grey

Color code 481

Color code 4602

Color code 317



3. LIGHT DUTY SLOTTED ANGLE RACK

Principles of Storing and Taking out

This is a line of shelves used to display goods in families and shops, so stock storing and taking out is done manually.

Strong point

- There are more beams to support decks, helping to store more goods.
- Save a lot of space and capital compared to using medium duty racks.

Weak point

- Small loading capacity, suitable for goods with moderate weight with loading capacity 120Kg/ shelf.
- High risk of buying poor quality products on the market



3. LIGHT DUTY SLOTTED ANGLE RACK



LAYOUT PLAN



4.MEDIUM DUTY RACK

Medium duty racks are specialized shelves with an average load of 200 to 1000 kg on a deck. The rack is divided into several shelves, the size of each shelf can be customized according to the needs of use.

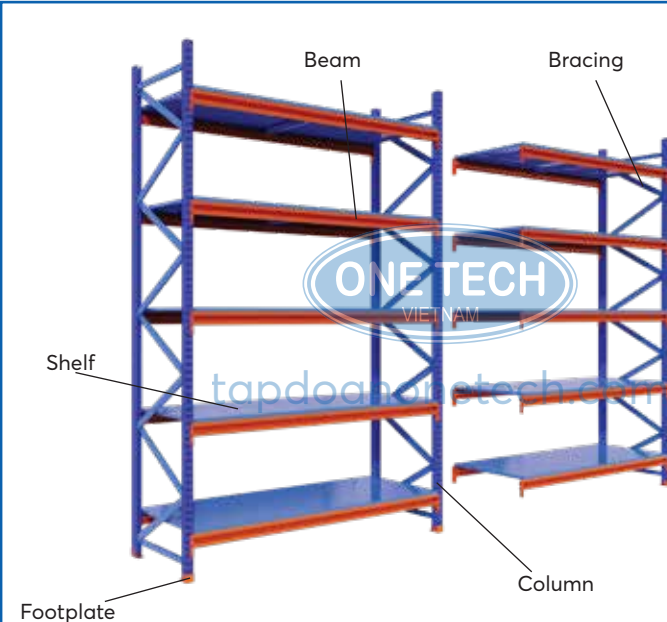
Most of the medium duty racks are intelligently designed, easy to assemble and disassemble and change flexibly. This rack can be used in both homes and warehouses, shops, etc., without loss of aesthetics and versatility.

	Column	Beam		
	Bracing	Shelf		
	Footplate	Jaw		
 <p>ONE TECH VIETNAM MANUFACTURING AND TRADING COMPANY LIMITED</p>	PRODUCT NAME		FULL NAME	
	<h3>MEDIUM DUTY RACK</h3>		DESIGN	
			TECHNICIAN	LE VAN NGHI
			CHECKED BY	NGUYEN CAO CUONG
			APPROVED BY	NGUYEN VAN TRUNG

Technical specifications

Medium Duty Rack	Unit	Standard dimensions
Height	mm	1000; 1500; 2000; 2500; 3000
Width	mm	400 -> 1200
Length	mm	1000 -> 5000
Loading capacity	kg	100; 200-700; 700-1000kg/tier
Column		50*30; 50*60; dày 0.8-1.6mm
Beam	mm	1.0 - 2,0
Thickness of shelf	mm	0.6mm, 0.8mm
Material		Stainless iron, Electrostatic powder coating iron
Color		Blue, orange

4. MEDIUM DUTY RACK

Models of Medium duty rack



Load < 200kg



Load 200-700kg



Load 700-1000kg

Popular models

Light – Medium duty rack : Load 100 -> 300kg

Number of tiers of Medium duty rack can be customized according to need of use of customers

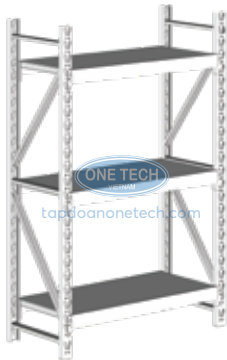

White



Black



Blue-orange

Medium duty rack : Load 200-700kg



2 tiers



3 tiers



4 tiers



5 tiers



6 tiers



4. MEDIUM DUTY RACK

Column foot parameters

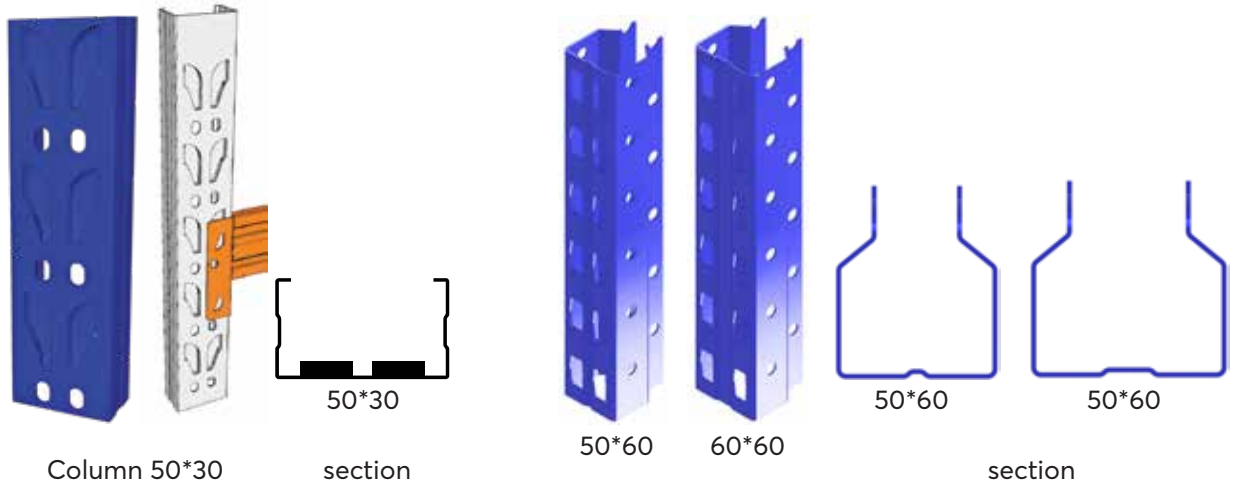

Column 50*30 section

Column 50*30mm
Thickness: 0.8-1.6

50*60 60*60

50*60 section

Column
Thickness: 0.8-1.6

Beam's parameters

H-shaped Beam – Thickness 1.0 - 2.0

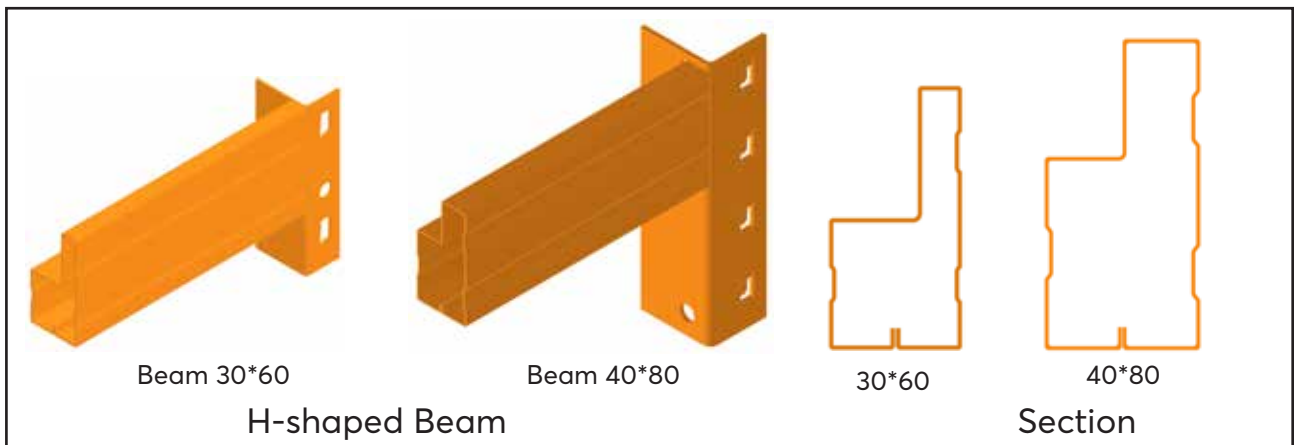

Beam 30*60

Beam 40*80

H-shaped Beam

30*60

40*80

Section

Z-shaped Beam – Thickness 1.0 - 2.0

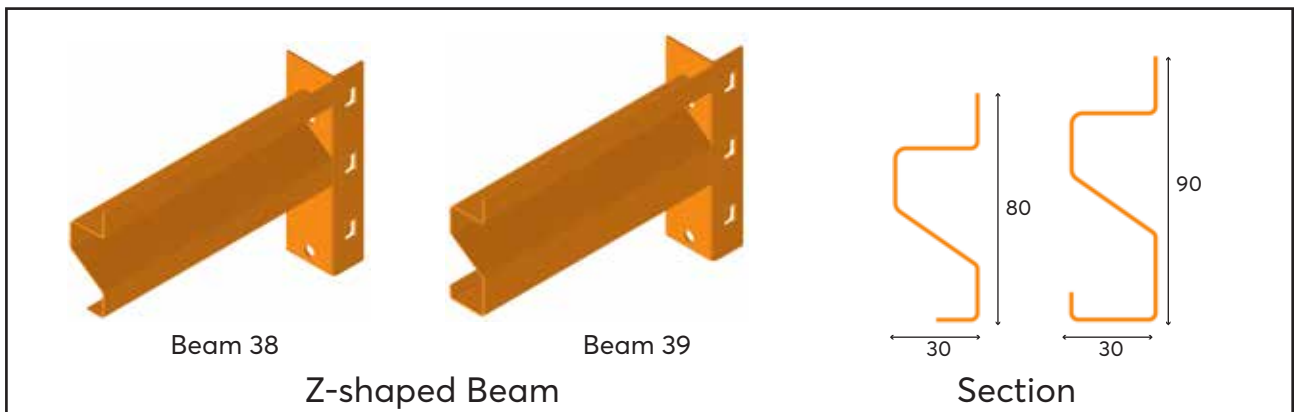

Beam 38

Beam 39

Z-shaped Beam

80

90

30

30

Section

4. MEDIUM DUTY RACK

Principles of Storing and Taking out

Used in factories and warehouses according to the FIFO (First In first out) goods access process, which is guaranteed to be simple, convenient and fast.

Ưu điểm

- Medium duty racks are suitable for goods with medium loads, not too heavy. Ensure the arrangement of goods is tidy, saving the maximum storage space.
- Be simple and easy assembly & disassembly. Be convenient and flexible in moving the medium duty racks to many different locations.

Weak points

Storage capacity is limited. If the goods are overloaded, the rack will easily reduce its bearing capacity and easily be broken. Manual loading and unloading, poor productivity

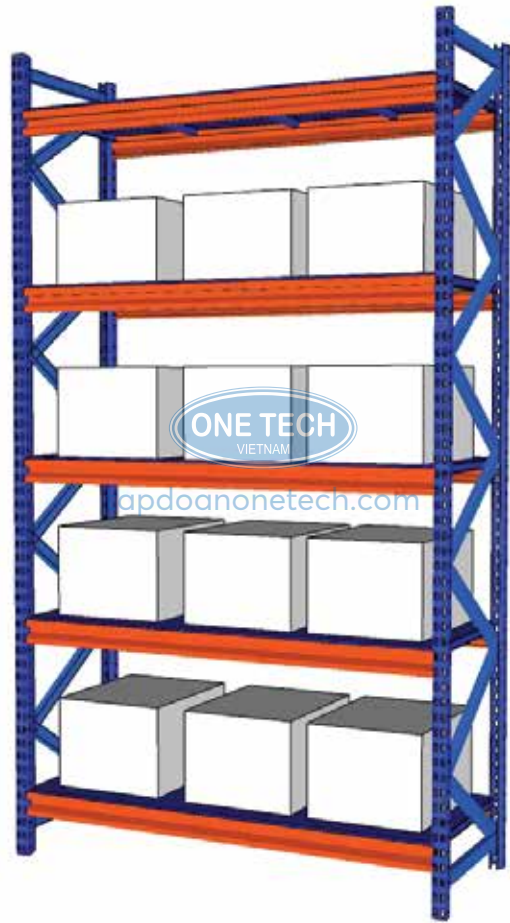

5. SELECTIVE RACK

Selective storage rack is a type of heavy-duty assembled storage rack used by many businesses and for the purpose of storing many different types of goods. Shelves have a flexible design with the ability to hold a pallet and then cascade the pallets on top for easy access later.

Components

	Column	Thanh Beam
	Bracing	Upright protector
	Footplate	Support bar
<p>ONE TECH VIETNAM MANUFACTURING AND TRADING COMPANY LIMITED</p>	PRODUCT	
	SELECTIVE RACK	
	DESIGN	FULL NAME
	TECHNICIAN	LE VAN NGHI
	CHECKED BY	NGUYEN CAO CUONG
APPROVED BY	NGUYEN VAN TRUNG	

Technical specifications

Selective rack	Unit	Standard dimensions
Size	mm	According to area of warehouse
Loading capacity	kg	1000 -> 3000kg/tier
Column thickness		1.5 -> 2.5
Beam	mm	1.2 -> 2,5
Support bar	mm	1.0 -> 1.4
Material		Stainless iron, Electrostatic powder coating iron
Color		Blue, orange

5. SELECTIVE RACK

Column parameters

Thickness of Column 1.5-2.5



90*60



100*60



90*70

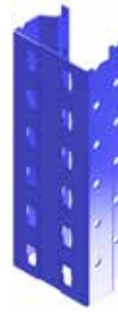

110*70



120*70

Column

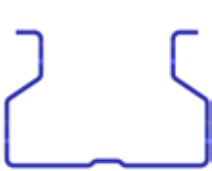

90*60



100*60



90*70



110*70



120*70

Section

Beam parameters

Thickness of beam 1.2-2.5



50*80



50*100



50*120



50*140



50*160



50*80



50*100



50*120



50*140



50*160

Section



5. SELECTIVE RACK

Principles of Storing and Taking out

Selective racking is the right solution for most pallets in both FIFO and LIFO methods. Helps increase convenience when using and can control the situation of storing and taking out goods quickly 100%.



Strong points

- Fits all pallet sizes and most forklift models
- Load capacity up to 5000 kg/tier
- Easy to adjust, upgrade, expand or replace
- Import and deliver goods unconstrainedly, access to 100% of goods
- Suitable to design with all types of industrial warehouses

Weak points

- Optimizing the storage area is not good (about 40%)
- Not suitable for long and bulky goods
- Not optimize costs for businesses



5. SELECTIVE RACK

Completed projects



6. DOUBLE DEEP RACK

Double deep rack is a type of industrial shelf that consists of two rows of selective double rack connected back to each other. Goods accessibility is only 50% compared to Selective rack. This reduces forklift aisles and limits access to goods by 50%, but in return it optimizes for nearly twice the storage space in the warehouse compared to Selective rack.

Components

	Column		Beam	
	Bracing		Column protector	
	Row spacer		Support bar	
	Column protector			
<p>ONE TECH VIETNAM MANUFACTURING AND TRADING COMPANY LIMITED</p>	PRODUCT		FULL NAME	
	<h2>DOUBLE DEEP RACK</h2>		DESIGN	
			TECHNICIAN	LE VAN NGHI
			CHECKED BY	NGUYEN CAO CUONG
			APPROVED BY	NGUYEN VAN TRUNG

Technical specifications

Selective rack	Unit	Standard dimensions
Size	mm	According to area of warehouse
Loading capacity	kg	1000 -> 3000kg/tier
Column thickness	mm	1.5 -> 2.5
Beam	mm	1.2 -> 2,5
Support bar	mm	1.0 -> 1.4
Material		Stainless iron, Electrostatic powder coating iron
Color		Blue, orange

6. DOUBLE DEEP RACK

Column parameters

Thickness of Column 1.5-2.5



90*60



100*60

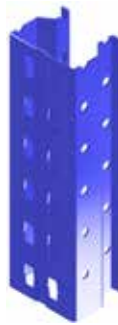

90*70

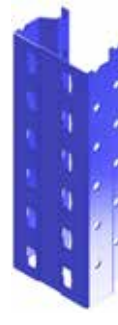

110*70



120*70

Column

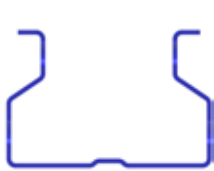

90*60



100*60

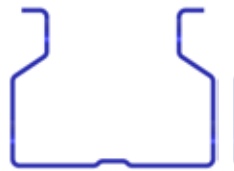

90*70



110*70



120*70

Section

Beam parameters

Thickness of beam 1.2-2.5



50*80



50*100



50*120



50*140



50*160



50*80

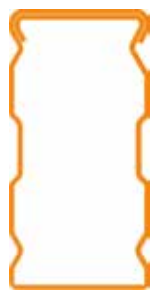

50*100



50*120



50*140



50*160

Section



6. DOUBLE DEEP RACK

Principles of Storing and Taking out

This rack follows the principle of storing and taking out LIFO. This means that the goods that put into storage first will be taken out first. With this racking system, the forklift will pass the rack, enter in one side of the system and exit on the other.



Strong points

Fits all pallet sizes and current forklifts

Optimizing storage space in the warehouse ~ 60%

Match the design with the characteristics of most warehouses

Weak points

Accessibility to goods is about 50%



6. DOUBLE DEEP RACK

Completed projects



7. MEZZANINE RACK

Mezzanine rack is an industrial racking system that helps create mezzanine floors for warehouses. This rack has high load capacity, creating 1-3 more floors in the warehouse to increase the warehouse area by 2-3 times.

Components

	Column	Beam		
	Wire deck	Support bar		
	Bracing			
<p>ONE TECH VIETNAM MANUFACTURING AND TRADING COMPANY LIMITED</p>	PRODUCT			
	<h1>MEZZANINE RACK</h1>		FULL NAME	
			DESIGN	
			TECHNICIAN	LE VAN NGHI
			CHECKED BY	NGUYEN CAO CUONG
	APPROVED BY	NGUYEN VAN TRUNG		

Technical specifications

Mezzanine Rack	Unit	Standard dimensions
Size	mm	According to area of warehouse
Handrail	mm	Thickness 0.7 -> 1.2
Thickness of column		1.5 -> 2.5
Beam	mm	50*100/120/140/160 thickness 1.2 -> 2.5
Support bar	mm	Thickness 0.8 -> 1.4
Material		Stainless iron, Electrostatic powder coating iron
Color		Blue, orange

7. MEZZANINE RACK

Column parameters

Thickness of Column 1.5-2.5

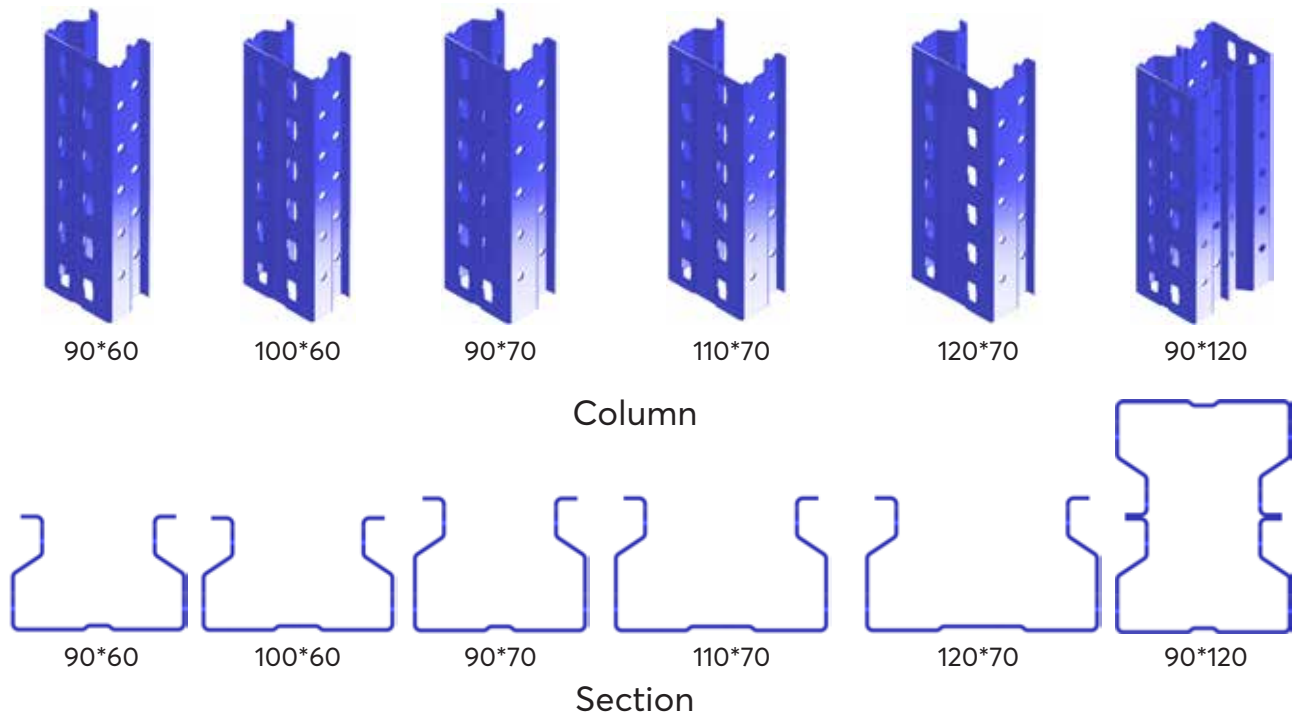

Beam parameters

Thickness of beam 1.2-2.5

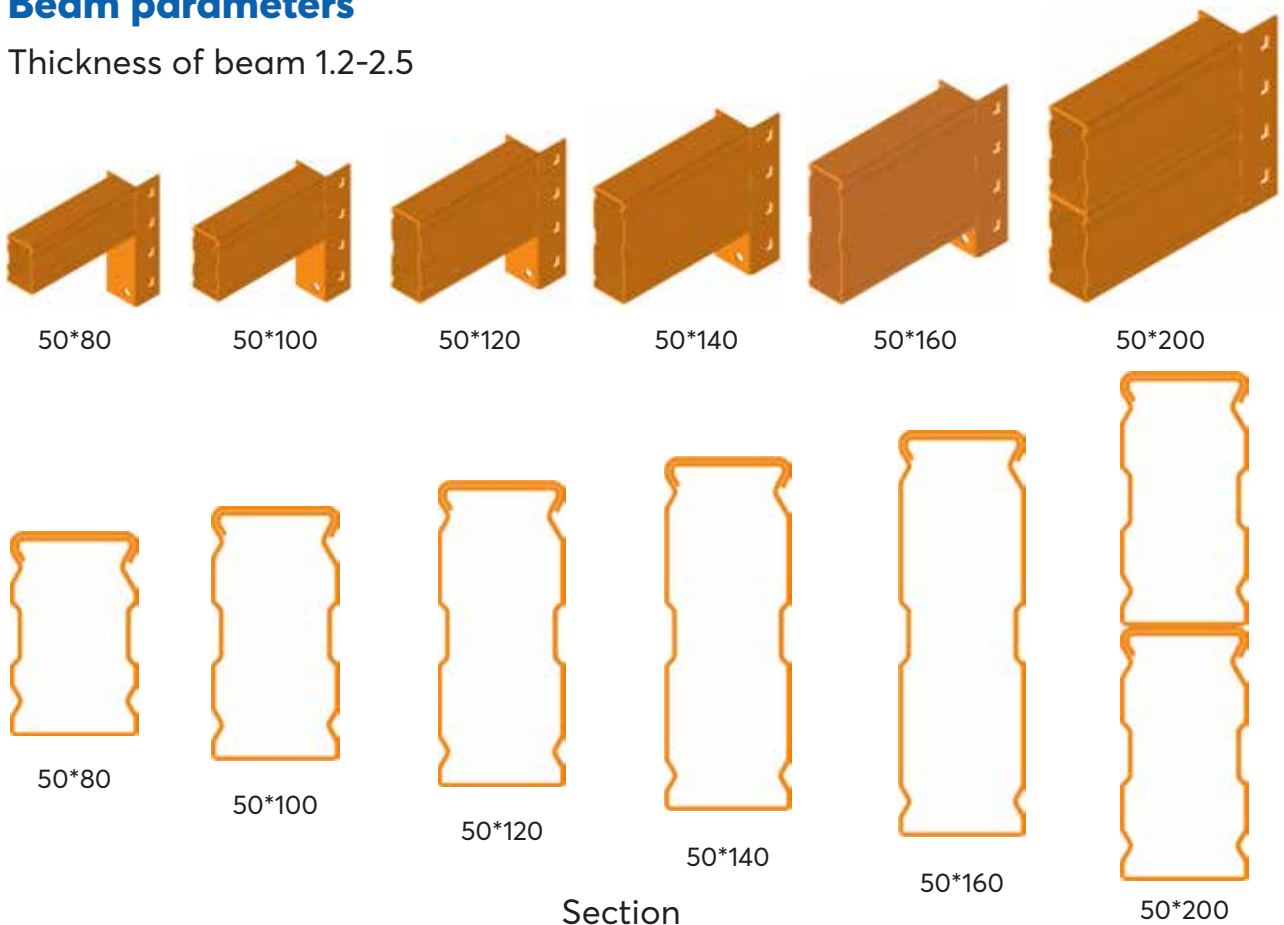

7. MEZZANINE RACK

Principles of Storing and Taking out

This rack works manually, all goods storing and taking out activities are done according to business owner's requirements

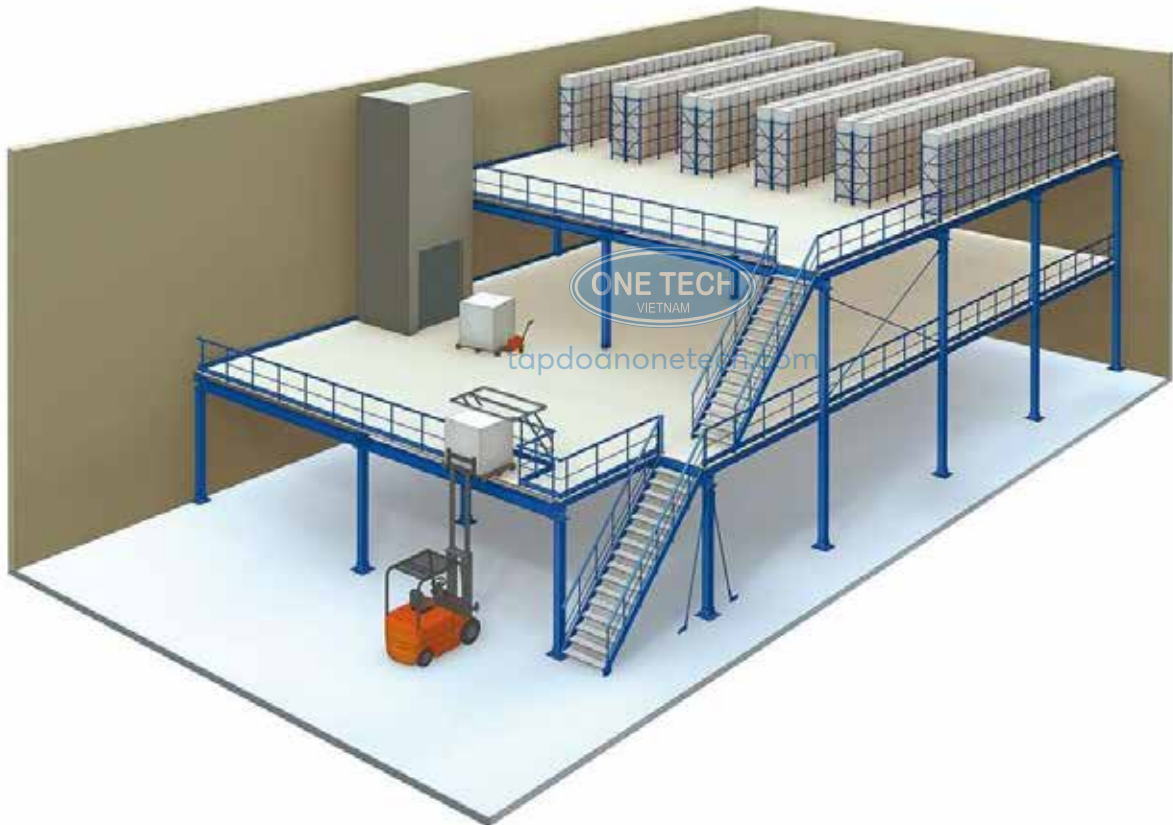

Strong points

Increase more mezzanine floor, maximize area of warehouse

Incorporate other industrial racks on the face of deck

Weak points

Complex structure, construction and erection requires much time



7. MEZZANINE RACK

Completed projects



8. DRIVE IN RACK

Drive in rack is the type of rack optimizing 90% area of storage of industrial warehouses. However, it requires some special conditions.

First condition is that pallet system containing goods must be uniform and suitable to rails. The forklift will move into storage rack from inside to outside, from lower position to higher position, respectively. This rack can be only used with a specialized forklift type used to squeeze into the row of rack or pick up goods.

Components

	Chân Omega	Beam	
	Rail stop	Pallet support bar	
	Bracing	Top bracing	
	Barrier protector	Column protector	
<p>ONE TECH VIETNAM MANUFACTURING AND TRADING COMPANY LIMITED</p>	PRODUCT	FULL NAME	
	DRIVE IN RACK	DESIGN	
		TECHNICIAN	LE VAN NGHI
		CHECKED BY	NGUYEN CAO CUONG
		APPROVED BY	NGUYEN VAN TRUNG

Technical specifications

Drive In rack	Unit	Standard dimensions
Size	mm	According to area of warehouse
Thickness of column	mm	1.5 -> 2.5
Beam	mm	50*100/120/140/160 thickness 1.2 -> 2.5
Support bar	mm	Thickness 0.8 -> 1.4
Material		Stainless iron, Electrostatic powder coating iron
Color		Blue, orange

8. DRIVE IN RACK

Column parameters

Thickness of Column 1.5-2.5



90*60



100*60



90*70

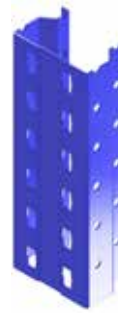

110*70



120*70

Column



90*60



100*60



90*70



110*70



120*70

Section

Beam parameters

Thickness of beam 1.2-2.5



50*80



50*100



50*120



50*140



50*160



50*80



50*100



50*120



50*140



50*160

Section



8. DRIVE IN RACK

Principles of storing and taking out

This racking system is popularly used. This rack helps to maximumly save aisle and works under management of warehouse following LIFO method, the last pallet will be firstly taken out.



Strong points

Can utilize at least 70% area of warehouse
Save the investment cost,
reduce cost of warehouse

Weak points

Accessibility to goods is low
Only used with uniform pallets and specialized forklift
It is required to comply with storing and taking out principle.



8. DRIVE IN RACK

Completed projects



9. PALLET FLOW RACK

For industrial goods requiring continuous transportation (line), using pallet flow rack is an optimum choice. This industrial storage rack features a design that slides the goods pallet from one end to the other automatically. Based on gravity and slope, the blocks will slide on the automatic roller easily.

Components

	Column	Beam
	Roller	Bracing
	Barrier protector	Column protector
<p>ONE TECH VIETNAM MANUFACTURING AND TRADING COMPANY LIMITED</p>	PRODUCT	
	PALLET FLOW RACK	
	DESIGN	
	TECHNICIAN	LE VAN NGHI
	CHECKED BY	NGUYEN CAO CUONG
APPROVED BY	NGUYEN VAN TRUNG	FULL NAME

Technical specifications

Drive In rack	Unit	Standard dimensions
Size	mm	According to area of warehouse
Thickness of column	mm	1.5 -> 2.5
Beam	mm	50*100/120/140/160 thickness 1.2 -> 2.5
Support bar	mm	Thickness 0.8 -> 1.4
Material		Stainless iron, Electrostatic powder coating iron
Color		Blue, orange

9. PALLET FLOW RACK

Column parameters

Thickness of Column 1.5-2.5



90*60



100*60



90*70

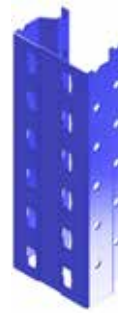

110*70



120*70

Column



90*60



100*60



90*70



110*70



120*70

Section

Beam parameters

Thickness of beam 1.2-2.5



50*80



50*100



50*120

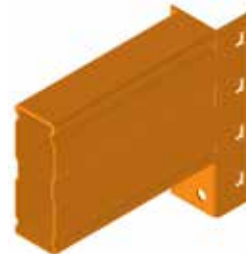

50*140



50*160



50*80



50*100



50*120



50*140



50*160

Section



9. PALLET FLOW RACK

Principles of storing and taking out

With the roller structure, the goods are easily moved inward or outward by movable sliding on the shelf surface. This type of racking is often used in warehouses with a large amount of goods, which need to be stored and taken out according to the principle of First In - First Out (FIFO).

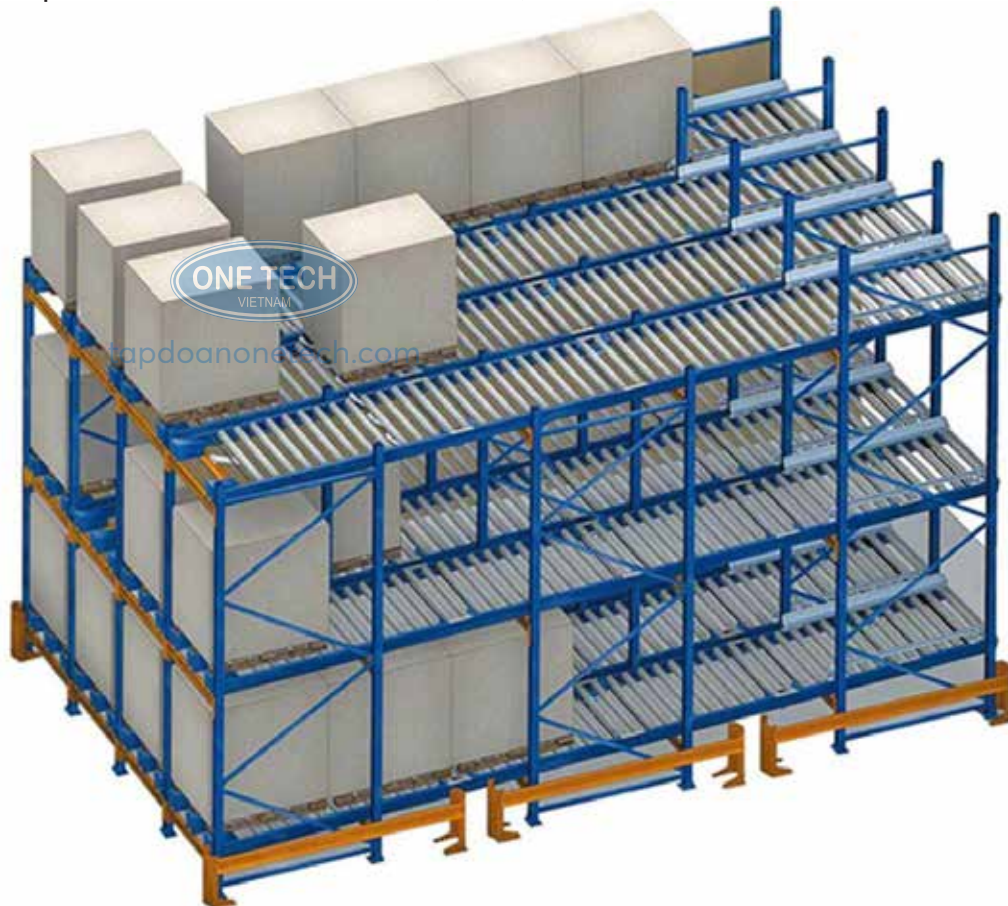

Strong points

Suitable for many types of warehouses. Install a variety of racking. Racks are electrostatic powder coated to prevent from rust and mildew.

Weak points

Rollers cannot withstand heavy loads.
Need regular maintenance of rollers.
Complicated assembly and repair process.



9. PALLET FLOW RACK

Completed projects



10. CANTILEVER RACK

Cantilever Rack is a type of shelf for industrial goods in cube, tubular, long size. For example, the iron and steel industry or the wood industry. It is easy to support steel bundles, wooden blocks 10-20m long, loads of tons on the arm easily.

Components

	Column	Bracing
	footplate	Arm
<p>ONE TECH VIETNAM MANUFACTURING AND TRADING COMPANY LIMITED</p>	PRODUCT	
	CANTILEVER RACK	
	DESIGN	
	TECHNICIAN	LE VAN NGHI
	CHECKED BY	NGUYEN CAO CUONG
APPROVED BY	NGUYEN VAN TRUNG	FULL NAME

Technical specifications

Cantilever rack	Unit	Standard dimensions
Size	mm	According to area of warehouse
Load capacity	kg	1500
Column	mm	180*120; 200*120; 180*140; 220*140; 240*140
Bracing	mm	30*60 -> 40*80
Arm	mm	50*80/100/120/140/160
Material		Stainless iron, Electrostatic powder coating iron
Color		Blue, orange

10. CANTILEVER RACK

Column parameters

Thickness of Column 1.5-2.5



Column

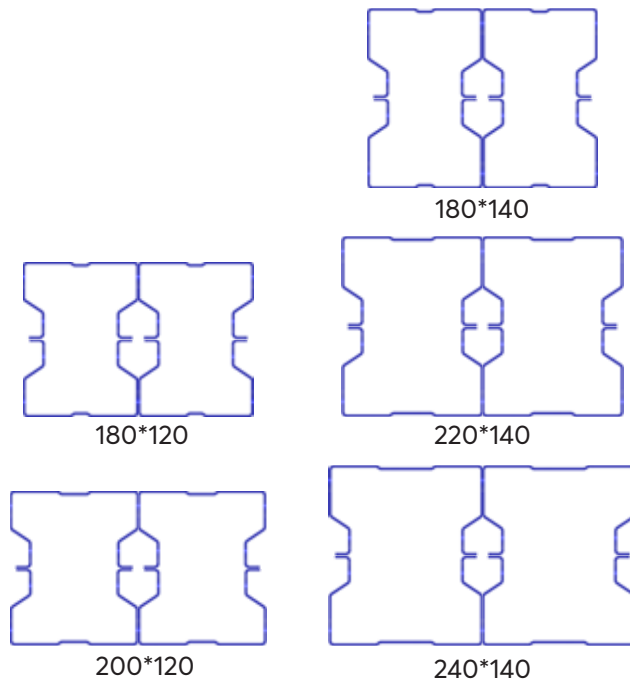

Section

Beam parameters

Thickness of beam 1.2-2.5



50*80

50*100

50*120

50*140

50*160

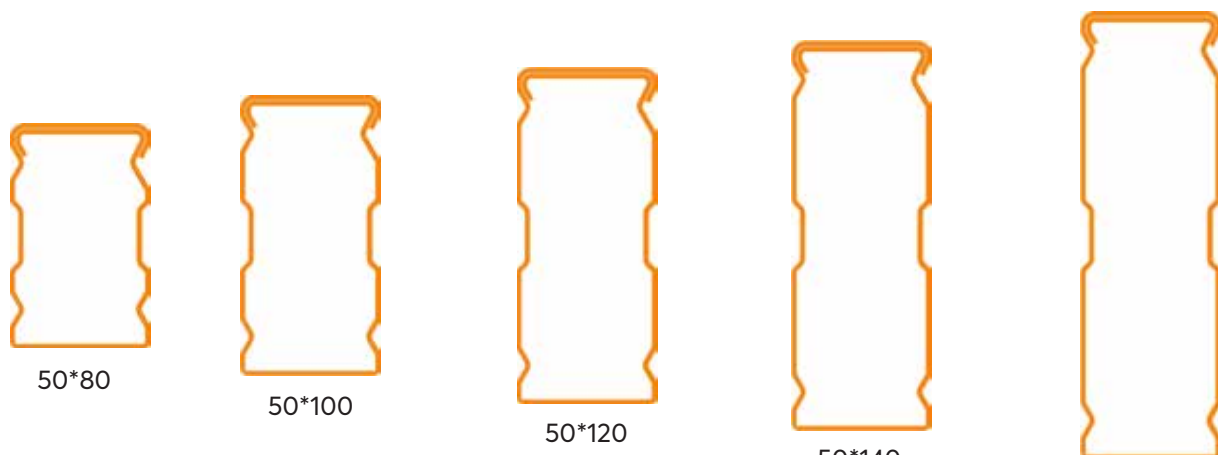

50*80

50*100

50*120

50*140

50*160

Section



10. CANTILEVER RACK

Principles of storing and taking out

This rack works manually, all goods storing and taking out activities are done according to business owner's requirements



Strong points

Suitable to industrial goods: sawn timber, steel pipe, carpets furniture, etc.

Low investment cost with high efficiency.

Accessibility to goods is 100%

Weak points

Only suitable for goods of certain sizes

Suitable for very large warehouse space



10. CANTILEVER RACK

Completed projects





TYPICAL
PROJECTS &
STRATEGIC
PARTNERS





**TRANSPORTATION
AND INSTALLATION
OF STORAGE RACKS**



“We are glad to be of service”





Factory in Hanoi



ĐÀ NẴNG



HỒ CHÍ MINH



01



200+
Agencies nationwide

02



200.000+
Projects

03



20+
Branches

CONTACT



0967.021.077 - 0963.021.077



onetechnvietnam@gmail.com



www.tapdoanonetech.com



CN5, Thach That Industrial Zone,
Quoc Oai, Hanoi